

Features

- ◆ 1:1 impedance ratio
- ◆ Surface mount
- ◆ Available on tape and reel
- ◆ 260°C reflow compatible
- ◆ RoHS Compliant and Pb free
- ◆ Excellent temperature stability
- ◆ Can be used on 50Ω and 75Ω systems
- ◆ RoHS version of ETC1-1T and MABACT0012

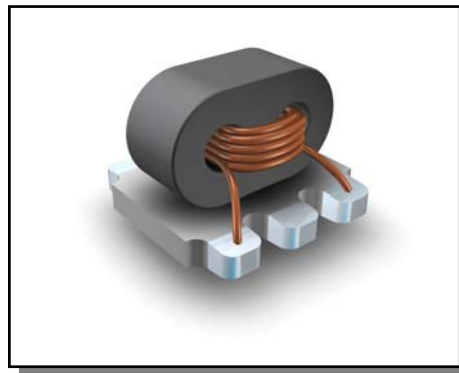

Electrical Specifications: $T_A = 25^\circ\text{C}$, $Z_0 = 50\Omega$, $P_{in} = 0\text{dBm}$

Parameter	Frequency	Units	Min	Typ	Max
Insertion Loss	3 - 50 MHz	dB	-	0.2	0.5
	50 - 160 MHz	dB	-	0.5	1.0
	160 - 200 MHz	dB	-	0.8	1.2
Amplitude Balance (Nominal 0dB)	3 - 50 MHz	dB	-	0.02	± 0.1
	50 - 200 MHz	dB	-	0.06	± 0.5
Phase Balance (Nominal 180°)	3 - 50 MHz	°	-	0.2	± 1.5
	50 - 200 MHz	°	-	0.5	± 5.0
Input Return Loss	3 - 200 MHz	dB	10	20	-
	5 - 100 MHz	dB	15	25	-

Electrical Specifications: $T_A = 25^\circ\text{C}$, $Z_0 = 75\Omega$, $P_{in} = 0\text{dBm}$

Parameter	Frequency	Units	Min	Typ	Max
Insertion Loss	3 - 5 MHz	dB	-	0.5	1.0
	5 - 65 MHz	dB	-	0.4	0.6
	65 - 200 MHz	dB	-	0.6	1.0
Amplitude Balance (Nominal 0dB)	3 - 65 MHz	dB	-	0.02	± 0.2
	65 - 200 MHz	dB	-	0.04	± 0.3
Phase Balance (Nominal 180°)	3 - 65 MHz	°	-	0.4	± 2.0
	65 - 200 MHz	°	-	1.2	± 5.0
Input Return Loss	3 - 5MHz	dB	18	24	-
	5 - 65 MHz	dB	21	29	-
	65 - 100 MHz	dB	19	25	-
	100 - 200 MHz	dB	14	20	-

Pin Configuration

Pin No.	Function
1	Secondary Dot
2	Secondary Center Tap
3	Secondary
4	Primary
5	Primary Dot

Schematic

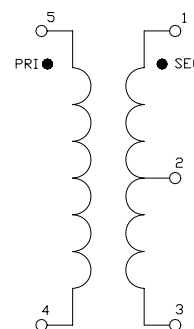

Insertion Loss

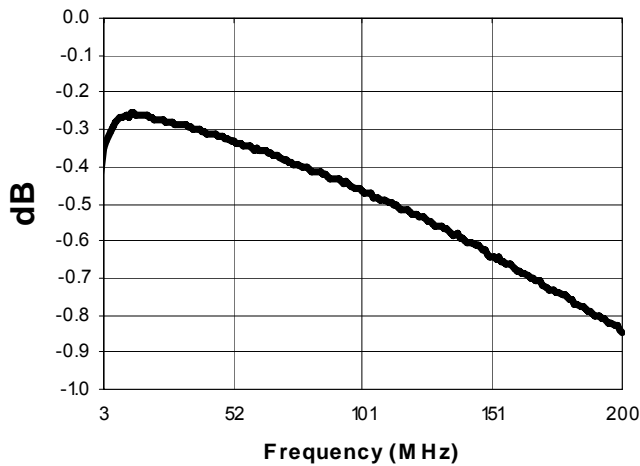

Amplitude Balance

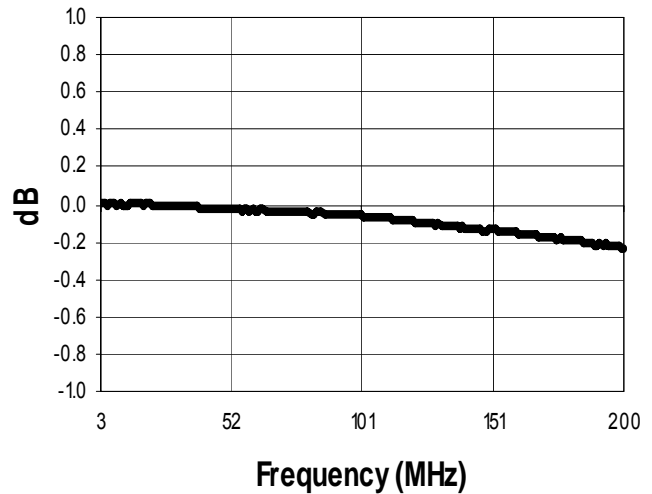

Input Return Loss

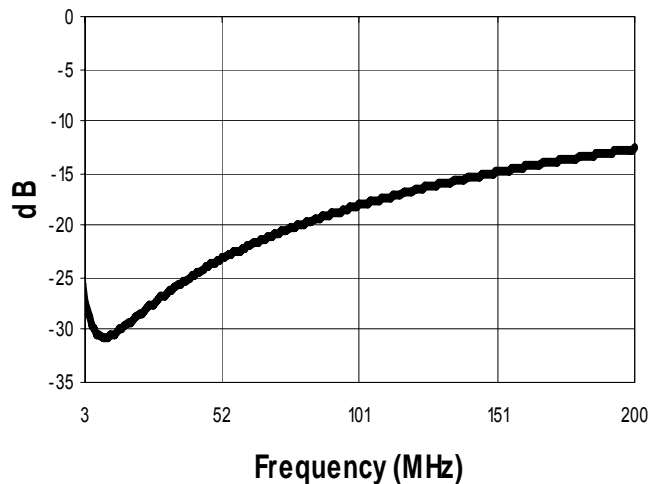

Phase Balance

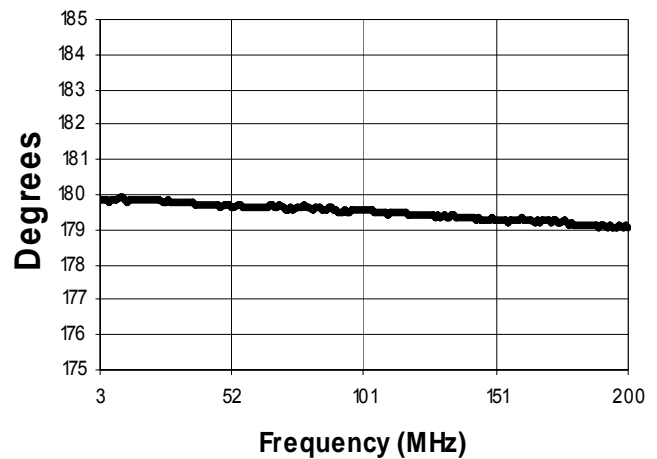

Electrical Specifications: $Z_0 = 50\Omega$, $T_A = 25^\circ\text{C}$, $P_{in} = 0\text{dBm}$

Outline Drawing

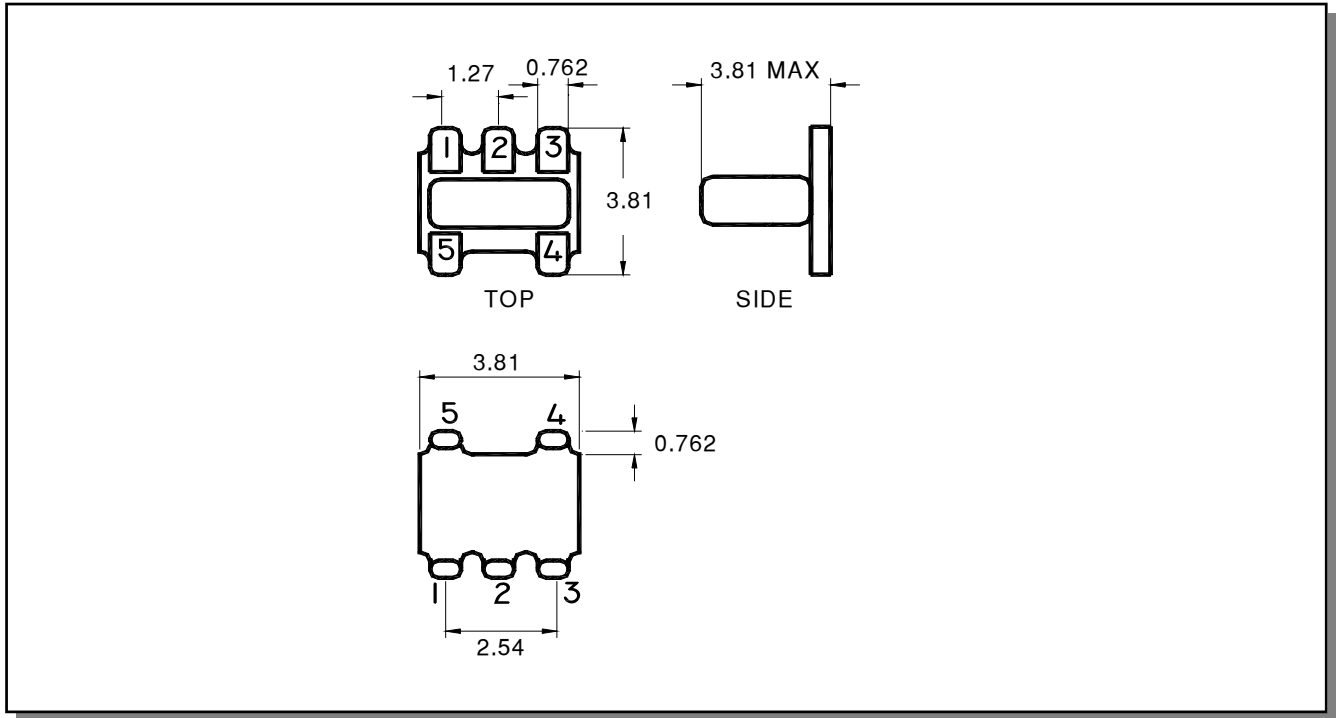

1. Dimensions in mm.
2. Tolerance: $\pm 0.2\text{mm}$ unless otherwise noted.
3. Model number and lot code are printed on the reel.

Recommended Footprint

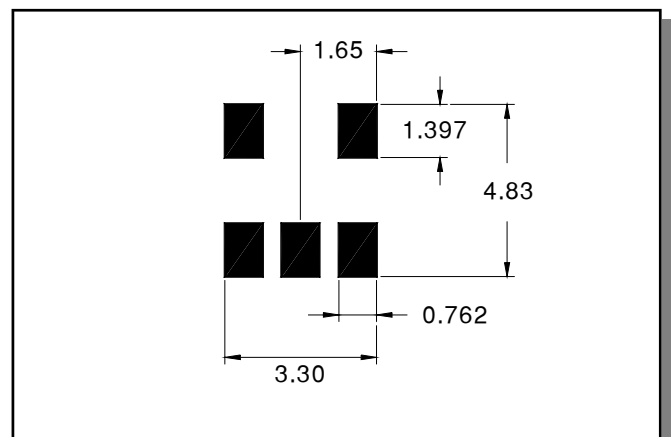

Tape & Reel Information

Parameter	Units	Value
Qty per reel	-	2000
Reel Size	mm	330
Tape Width	mm	12.00
Pitch	mm	8.00
Ao	mm	4.00
Bo	mm	4.00
Ko	mm	2.90
Orientation	-	F5
Reference Application Note ANI-019 for orientation		

Ordering Information

Part Number	Description
MABA CT0062	Tape & Reel
MABA-008115-CT62TB	Customer Evaluation Board

Recommended Maximum Ratings

Parameter	Units	Min	Max
Input Power	mW		250
DC Current	mA		200
Operating Temperature Range	°C	-40	+85
Storage Temperature Range	°C	-55	+125

ECO History

Rev	Date	Description	By
V4	10 May 2010	Corrected the case style drawing and changed to the new format	MOC